



Noha[®]
the invisible handle



for **SWING** doors – NM series



for **SLIDING** doors – NS series



for **FURNITURE** – NK series



the **ACCESSORIES**

Noha[®]
the invisible handle



for **SWING** doors – NM series

No-Ha mini is a real innovation which is why it was patented. The system integrates door handle and magnetic lock in one box.

It enables doors to be opened and shut without a visible door handle.

The handle can be completely hidden by giving the catch the same finish as the door and walls.



NM 938
Without privacy lock



NM 937
With privacy lock



for **SWING** doors – NM 938

This is the handle you need for the majority of your interior doors. You have all the functionalities of the invisible handle without the locking mechanism.



NM 938 S0/...

This is the version with the longer striking plate, this is the original solution. Available in different finishes of front plates:

SATIN CHROME	NM 938 S0/SC
POLISH CHROME	NM 938 S0/PC
POLISH BRASS	NM 938 S0/PB
BLACK	NM 938 S0/BL
WHITE	NM 938 S0/WT



NM 938 S5/...

This is the version with the shorter striking plate:

SATIN CHROME	NM 938 S5/SC
BLACK	NM 938 S5/BL
WHITE	NM 938 S5/WT



for **SWING** doors – NM 937

This is the handle you need for your bathroom doors. You have all the functionalities of the invisible handle and gives you the privacy at the inside of your bathroom with a one sided locking mechanism. There is still an emergency option to open it from the outside.

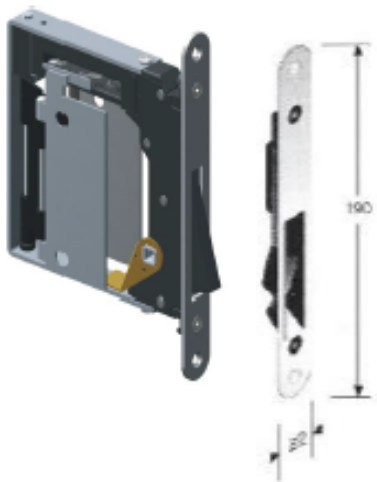

NM 937 S0/...

This is the version with the longer striking plate, this is the original solution. Available in different finishes of front plates:

SATIN CHROME	NM 937 S0/SC
POLISH CHROME	NM 937 S0/PC
POLISH BRASS	NM 937 S0/PB
BLACK	NM 937 S0/BL
WHITE	NM 937 S0/WT

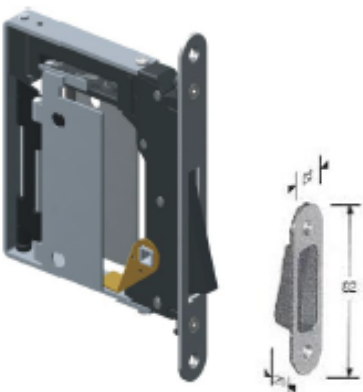

NM 937 S5/...

This is the version with the shorter striking plate:

SATIN CHROME	NM 937 S5/SC
BLACK	NM 937 S5/BL
WHITE	NM 937 S5/WT

Noha[®]
the invisible handle



for **SLIDING** doors – NS series

The NS series are door handles that recede into the door panel and can be used on all sliding doors that slide into the wall or in front of it. The handle is operable on both sides with plenty of space for the fingers. The handle has the same look as the No-Ha for swing doors.

NS 200

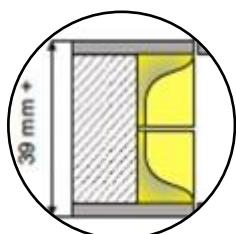

NS 205

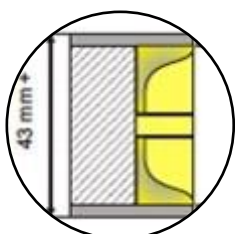

NS 210

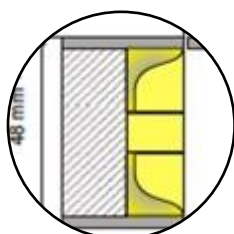

NS 105

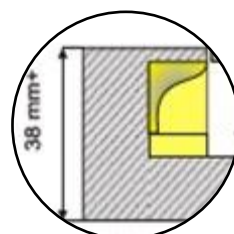

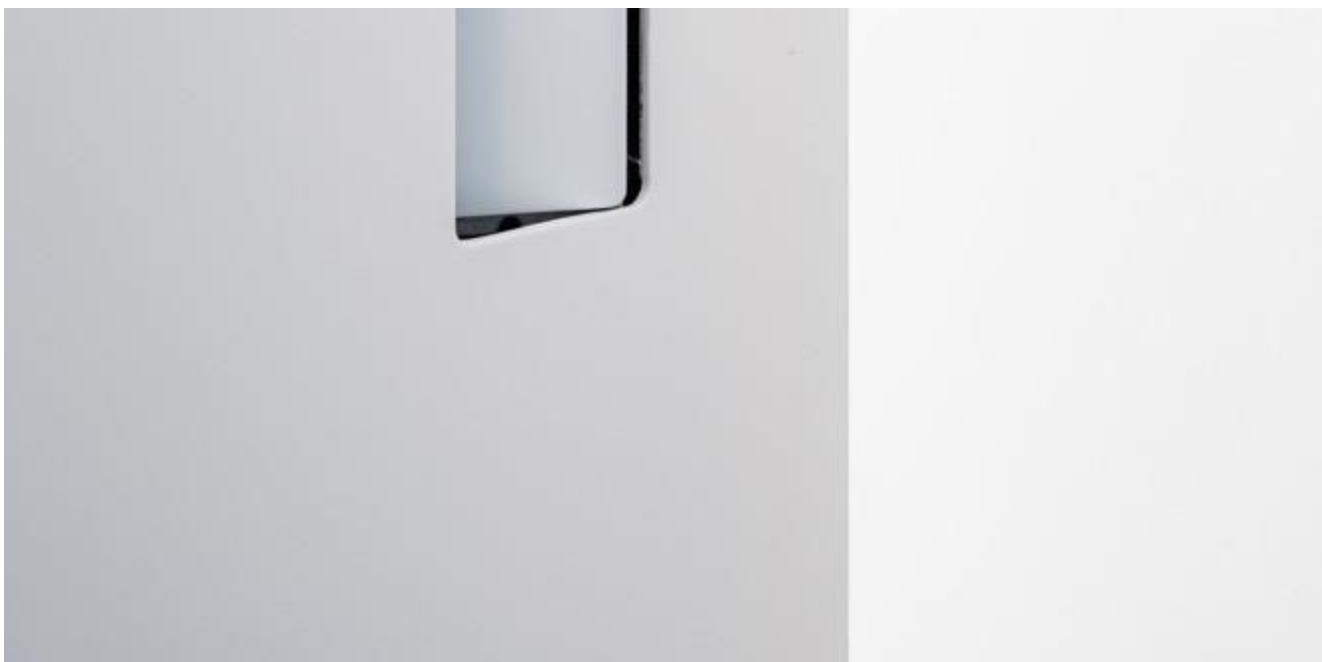

for **SLIDING** doors – NS series

This is the handle you need for all sliding doors and pivoting doors. You can apply it 1 sided or both sided. The product type depends on the thickness of the door panel.



NS 200

2-sided handle

Thickness 38mm – 43 mm

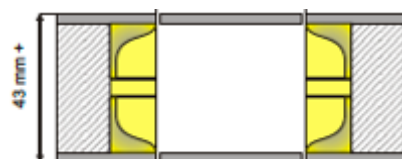

NS 205

2-sided handle

Thickness 43mm – 48 mm

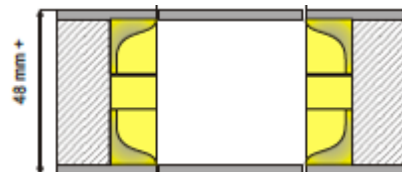

NS 210

2-sided handle

Thickness 48mm – 52 mm

for doors with thickness more than 52 mm, you can use 2 x NS 105 on both sides.

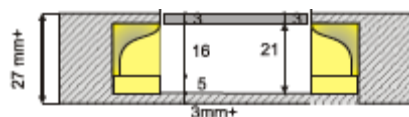

NS 105

1-sided handle

Thickness 27mm – unlimited

Noha[®]
the invisible handle

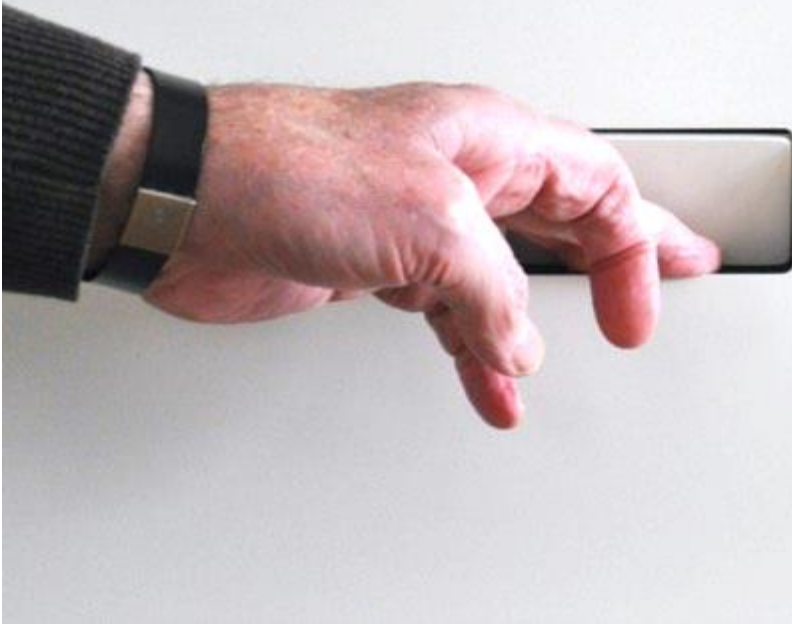

for **FURNITURE** – NK 250

The NK 250 is a handle with plenty of space for the fingers that recedes into the panel and can be used on all drawers, sliding doors for cupboards and revolving doors for cupboards. The handle has the same look as the No-Ha for swing doors and sliding doors.

NK 250

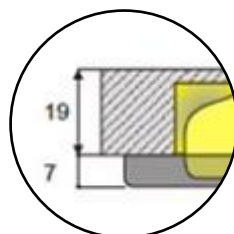



for **FURNITURE** doors – NK 250

This is the handle you need for all sliding doors and pivoting doors. You can apply it 1 sided or both sided. The product type depends on the thickness of the doorleaf.



NK 250

1-sided handle

Thickness 19mm – 27 mm

for panels with thickness more than 27 mm,
you can use NS 105.

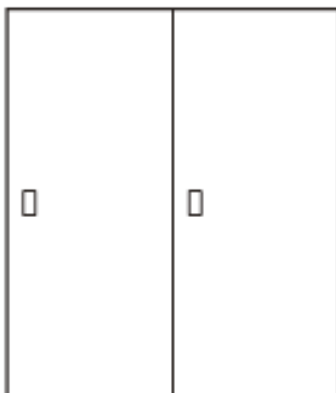
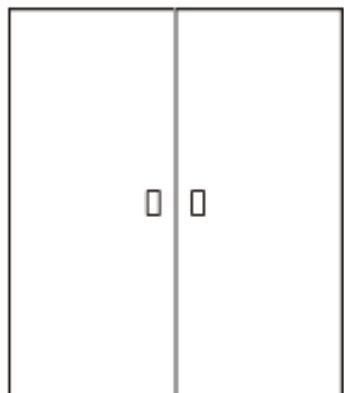
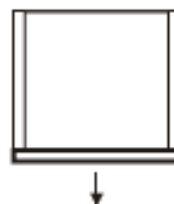
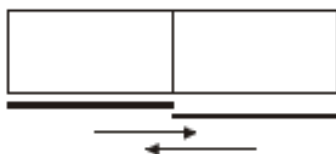
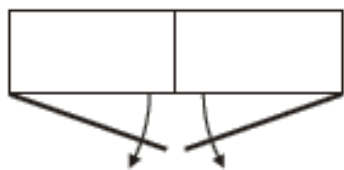

Noha[®]
the invisible handle



to **MAKE** it all perfect – ACCESSORIES

The No-ha collection integrates handles into your projects. To make your project look perfect we optionally offer cover plates, privacy knobs and even milling tools to facilitate the installation work.

KNOBS



COVER PLATES



TOOLS





for **PRIVACY** lock – doorknobs

The doorknobs have been specially designed for the NM 937 in order to retain the door's minimalist appearance as much as possible. They are made of stainless steel and are used to lock the toilet door on one side. Other commercially available doorknobs may also be used, as long as the #6x6 square spindle is made of a non-ferrous metal.

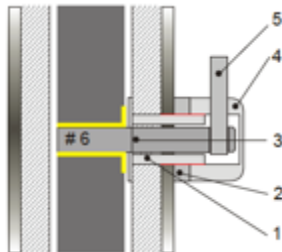

S011 - Locco

1-sided button

S011 = satin chrome

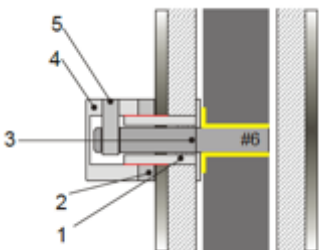

S012 - Cartel

1-sided button

S012 = satin chrome

S012 - PC = polish chrome

S012 - PB = polish brass

S012 - BL = black

S012 - WT = white

In case of emergency, the door can be unlocked from the outside by sliding a plastic card or similar from top to bottom in the handle at the level of the lock..

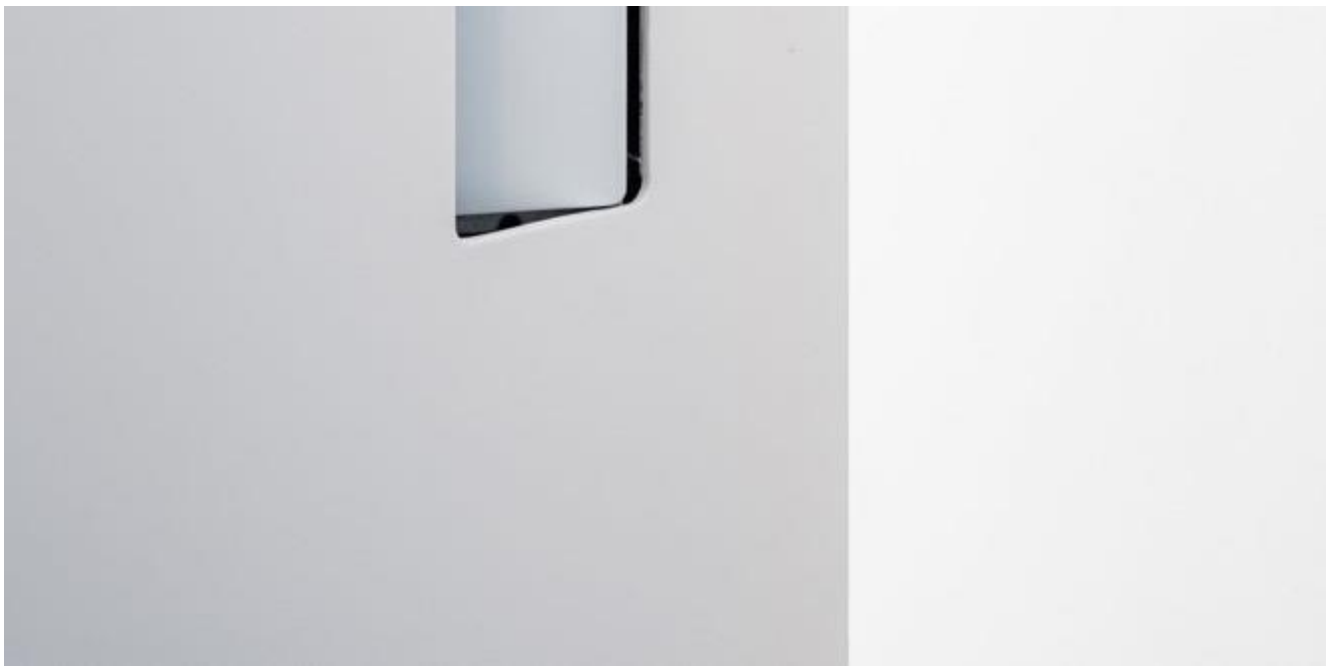

for **ALL** handles – cover plates

To finish the No-ha handle in the surface of your doorpanel you can both use your own cover plates that you produce from the same material as the doorleaf. We also have a range of ready to use cover plates.

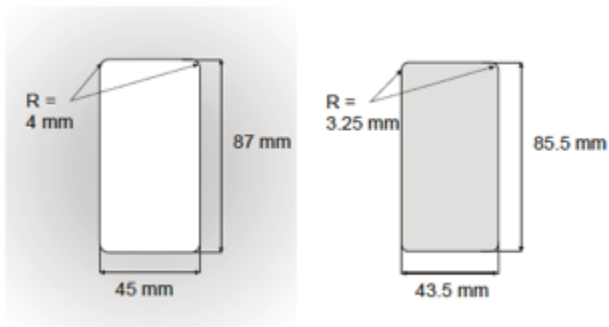

COVER PLATES

Ready to glue to the lock

P01 – MDF prepaint

P02 – INOX, brushed stainless steel

P03 – Bronze

P04 – Enamel light yellow

P05 - Enamel light blue

P06 - Enamel light green

P07 - Enamel light pink

P08 - Enamel dark brown





for **EASY** installation – cutter tool

This tool is used to do the milling inside the panel. The 3 available models have the same purpose but differ in the number of knives or axe diameter to fit your machine.

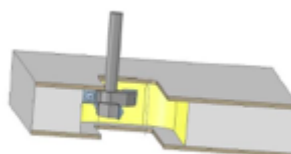

Z44-2 12	Z44-PRO 12	Z44-PRO 10



the **STORY** behind No-ha

No-ha has its origin in Belgium in 2005; it is then that we made our first prototype and started the development of "the invisible handle".

"In that period, together with my father, I developed the most appealing door solutions that have even become the standard today. We pioneered the development of hidden door frames and even achieved a Red Dot: best of the best with the development of SecretSlide, a sliding door with invisible rail.

After all these years, No-ha has become a collection with which anything is possible, with which handles can disappear into the interior or just provide a sparkle in your living room.

In this way No-ha has become a family business, but much more than a family business we are a father and son with the same passion for inventing and we will always continue to do so."



HEAD OFFICE
Maarschalk Gerardstraat 5
2000 Antwerp
Belgium
+32 (0)489 511 741
info@no-ha.com
www.no-ha.com

Noha[®]
the invisible handle

